



Quick Start Guide

AS420

4x4 Dual Band

802.11ac Wave 2 Indoor Access Point



Package Contents



One indoor
access point



One mounting bracket
+ one screw



Two mounting bracket screws
+ screw anchors



One
allen wrench



One quick start guide

Installation Requirements

TERMS OF USE: All Ethernet cabling runs must use CAT5e, 24 AWG (or above) Shielded Twisted Pair (STP) cabling. In addition, please cut the cable into a proper length, strip the cables on both ends, and crimp the wires into RJ45 connectors. It is the professional installer's responsibility to follow local country regulations, including operation within legal frequency channels, output power, indoor cabling requirements, and Dynamic Frequency Selection (DFS) requirements.

Mounting the Access Point

In-wall mount

- ① Determine where you want to mount the device, position the socket into the slot.
- ② Insert the mounting bracket into the socket using the two screws (included in the packaging).
- ③ Slide the device onto the mounting bracket to finish the installation.

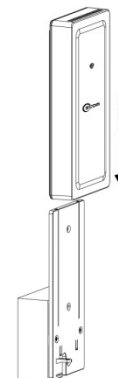
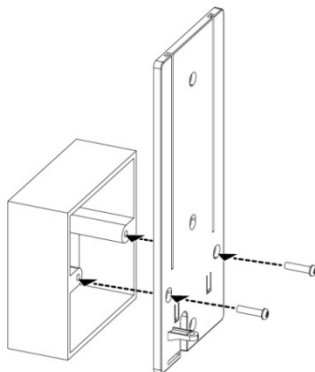

Note: Before lock two screws into the socket, please reserve space up to 15 cm in length above bracket for installation.

Wall mount

- ① Determine where you want to mount the device, position the mounting bracket onto the wall, and use a marker to mark the two screw holes on the wall.



Note: Before drill two holes into the wall, please reserve space up to 15 cm in length above bracket for installation.

- ② Drill the two holes into the wall and insert the two screw anchors (included in the packaging) into the holes.
- ③ Install the mounting bracket onto the wall using the two screws (included in the packaging) into the screw plugs in the wall.
- ④ Slide the device onto the mounting bracket to finish the installation.

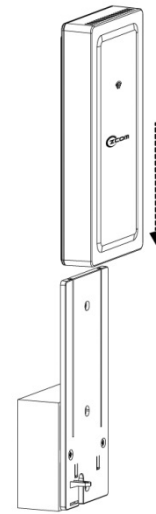
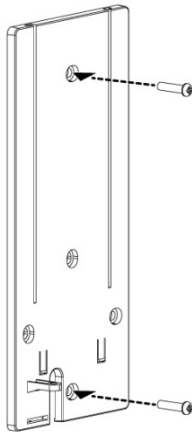

Ceiling Mount (Optional accessory_AS-CLM4)

- ① Determine where you want to mount the device, position the mounting bracket onto the ceiling board.
- ② Use a marker to locate the two screw holes on the ceiling, and drill the two holes into the ceiling.



Note: The thickness of ceiling board should be less than 15mm.

- ③ Insert the ceiling screw through the mounting bracket, ceiling board, and ceiling mount as the following picture.
- ④ Slide the device onto the mounting bracket to finish the installation.

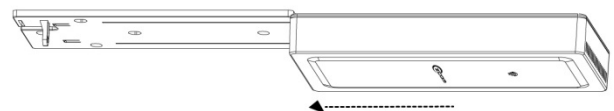
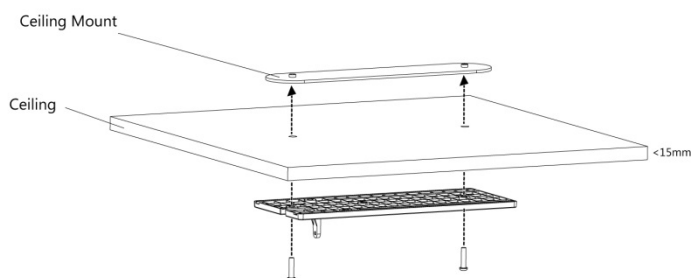

Installing the Anti-tamper Lock (Optional accessory_AS-LK18)

- ① Slide all the cables through their respective holes on the anti-tamper lock.
- ② Install the mounting bracket; plug all the cables into their respective ports on the device before installing the anti-tamper lock.
- ③ Position the anti-tamper lock onto the device and fasten the lock screw clock-wise with special anti-tamper lock key.

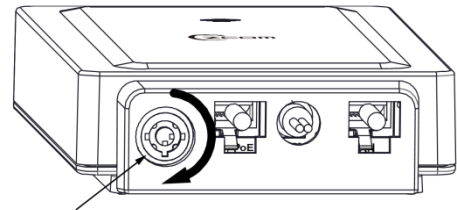
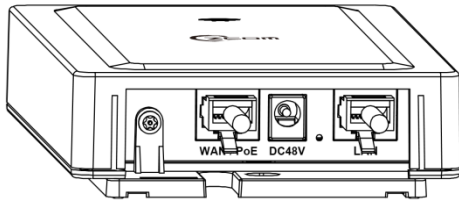

Safety Notice

1. Do not install the device close to any electrical grounding device or lightning protection system. Place the device's own grounding and lightning protection system apart from any electrical grounding device and lightning protection system as far as possible.
2. Protect components from electrostatic discharge: Please wear an ESD wrist strap or handle the power adapter by its edge and do not touch any component or printed circuit boards, especially for module device.
3. Make sure to keep the temperature and humidity of the installation location at an optimal level.
4. An excellent grounding system guarantees the stable operation of device, as well as to protect device from lightning, interference and electrostatic discharges.
5. If installed outdoors, the device may be damaged by lightning. We recommend that you install additional lightning protection devices if necessary, considering the conditions in your area.
6. Supply stable power to the device. Unstable power may cause the device to malfunction. The device supports PoE power supply and is recommended if the device is installed near grid lines within less than 100 meters radius.

Powering the Access Point

 **Note:** It's available to turn on the access point by either ① or ②.

By WAN/PoE

① Connect the PoE cable into the WAN/PoE IN port of the device.

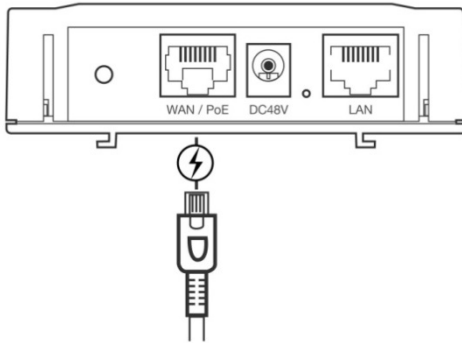



By a power adapter

(Optional accessory AC-48052)

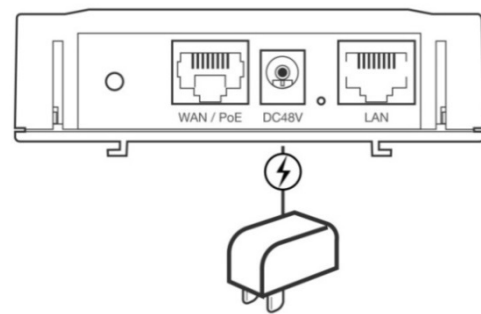
② Connect the power adapter into the DC port of the device.



 **Note:** Please wait for 5-10 seconds while powering on.

 **Note:** For PoE Out applications, the LAN port provides DC 48V, Max. 208mA, and up to 10W power supply. The positive side of the 48V is connected to pin 4 and 5, the negative side is connected to pin 7 and 8.

 **Warning:** Do **NOT** attempt to connect any **non-PoE** devices to LAN port and make sure the input power should comply with PoE Out standard.

LED Indicator

Color	Behavior	Description
Red	Steady	Initializing
	Flashing	Factory defaults, waiting to be integrated
Blue	Flashing	Device is busy updating its firmware; do not touch or unplug it
Green	Steady	Internet connection detected
	Flashing	No internet connection detected

Access Point Configuration

In a default access point configuration, the access point default AP mode is TAP mode, and obtains IP addresses from DHCP Option 43 protocol.

 **Note:** In TAP mode, the AP must be able to go with Wireless LAN Controllers (WLCs) for bulk configuration and performing other commands of access points. Please refer to WLC QSG for settings first, then go back to finish the AP configuration.

https://www.zcom.com.tw/index/downloads?keyword=&material_type=49

Step 1. Power on the access point. As the status of LED indicator from flashing change to steady green, the connection is successful.

 **Note:** Please make sure DHCP server is enabled on the network once accomplished WLC settings. The access point must receive its IP address through DHCP server.



Note: Switching from DHCP to assign a static IP address or DNS and L2 discovery mode to the access point, please refer to the user manual for more information.

https://www.zcom.com.tw/index/downloads?keyword=&material_type=25

If the access point cannot connect to the WLC by DHCP broadcast, please refer to the following optional settings.

Optional: Set up a static IP address



Note: The following procedure assumes that Windows 10 is the operating system. Procedures for other operating systems are similar.

- Step 1. On your computer, configure your network adapter from the "Local Area Connection" settings as follows:
 - Start→Control Panel→Network & Internet→Change Adapter Options→Ethernet
- Step 2. Edit the TCP/IPv4 address setting as follows:
 - Properties→Internet Protocol Version 4 (TCP/IPv4)
- Step 3. Select "Use the following IP address" and make the following entries:
 - IP address: 192.168.1.168 (or any available address in the 192.168.1.x network, except 192.168.1.1)
 - Subnet mask: 255.255.255.0Leave the "Default gateway" and "DNS server" fields empty.
- Step 4. Click "OK" to save your changes.

Login into the access point

- Step 5. Launch a Web browser; type default URL 192.168.1.1 to connect to the access point. When a security alert dialog box appears, click OK/Yes to proceed.
- Step 6. When login page appears, enter the following: Username: **root**/Password: **password**
- Step 7. Click login.

Customizing the Wireless Settings

On the Web interface menu, Select Status→General in the menu bar. Check your switchmod item to select "Connect with via IP", and setup your WLC IP address on "Wireless Switch Address 1".



Note: IP address of WLC needs to be assigned (ex. 192.168.1.228) while on operation.



Note: If you need a standalone access point, please change to FAP mode.

FAP Mode

The default AP mode is TAP mode, before FAP configurations please change AP mode.

Step 1. Currently in TAP Mode: On the Web interface menu, click System→AP mode.

Step 2. Select Fat AP from the drop-down list.

Step 3. Click save & apply to take effect.



Note: For FAP mode, please refer to the user manual for more information.

https://www.zcom.com.tw/index/downloads?keyword=&material_type=25

Mobile APP

Z-COM offers the App for bridge mode settings. Please research and download it to provision.

If necessary: reset button

If the access point needs to be reset, please press and hold the reset button for more than ten seconds to restore to factory default settings.

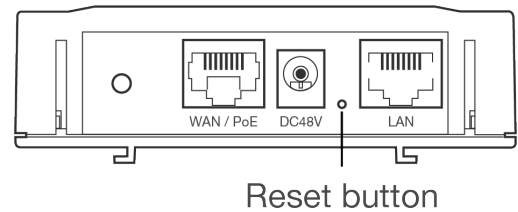

Technical Specifications

Physical			
Dimensions (L x W x H)	96 x 29.9 x 192 mm (3.78 x 1.18 x 7.56 in)	WAN/PoE In Port	One 10/100/1000 Mbps port
Weight	500 grams (1.1 lbs.)	LAN/PoE Out Port	One 10/100/1000 Mbps port
Antenna	2.4GHz: Embedded 3dBi omni antennas 5GHz: Embedded 3.3dBi omni antennas		
Power Supply	DC 48V, 0.5A PoE, or DC Jack (optional accessory)		
LAN/PoE Out	48V/10 Watts (Max.), Passive PoE (Pairs 4, 5+; 7, 8 Return)		
Power Consumption	Max. 15 Watts		

Environmental		
	Temperature	Humidity
Operating	-10°C to 50°C (14°F to 130°F)	10% to 90% (Non-condensing)
Storage	-20°C to 70°C (-4°F to 158°F)	10% to 90% (Non-condensing)

Compliance

RF Exposure Warning

The antennas used for this transmitter must be installed to provide a separation distance of at least 20 cm from all persons and must not be located or operating in conjunction with any other antenna or transmitter.

CE Marking

CE marking on this product represents the product is in compliance with all directives that are applicable to it.



Note: This device meets Max. TX power limit per ETSI regulations.



Note: This device is restricted to indoor use only when operating in the 5150 - 5350 MHz frequency range within all member states.

WEEE Compliance Statement



European Directive 2012/19/EU requires that the equipment bearing this symbol on the product and/ or its packaging must not be disposed of with unsorted municipal waste. The symbol indicates that this product should be disposed of separately from regular household waste streams. It is your responsibility to dispose of this and other electric and electronic equipment via designated collection facilities appointed by the government or local authorities. Correct disposal and recycling will help prevent potential negative consequences to the environment and human health. For more detailed information about the disposal of your old equipment, please contact your local authorities, waste disposal service, or the shop where you purchased the product.

Declaration of Conformity

Hereby, Z-COM, Inc. declares that the radio devices are in compliance with Directive 2014/53/EU. The full text of the EU declaration of conformity is available at the following internet address:
https://www.zcom.com.tw/index/downloads?keyword=&material_type=56

Optional Accessories

PN	Item	Picture
AS-CLM4	Ceiling mount + two screws	
AS-LK18	Anti-tamper Lock	
AS-48052-XX	48V 0.52A power adaptor	
SP-48063-XX	48V PoE Injector + power code	



Note: When ordering power adaptors, you must specify the destination region by indicating -US, -EU instead of -XX.

Contact Information

All information may be changed by Z-COM at any time without prior notice or explanation to the user. For further information please refer to our website: www.zcom.com.tw

Z-COM, Inc.

5F, No. 8, Hsin-Ann Road, Hsinchu Science Park, Hsinchu, Taiwan

Tel.: +886 35777364 Fax: +886 35773359

www.zcom.com.tw

